

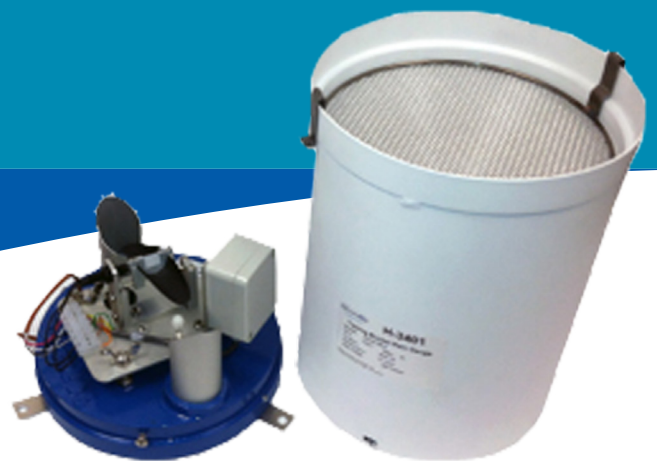

H-3401 SDI Rain Gauge

GETTING STARTED GUIDE



This guide is a brief overview of the H-3401 Tipping Bucket Rain Gauge and its basic features. Please refer to waterlog.com/rain-gauge or contact your sales representative for more information. Updated manuals, brochures, and technical notes are available online.

For additional assistance, please contact us at +1.435.753.2212 or sales@waterlog.com

CONTENTS

- Know Your Rain Gauge..... 1
 - What’s in the Box.....2
- Connect & Install.....3
 - Wire The Terminal Block.....4
 - Install Your Rain Gauge.....4
- Program & Calibrate.....5
 - Program Your Data Logger.....6
 - On-site User Calibration.....7
 - Adjust the Tipping Bucket Mechanism.....8
 - Volume Test.....8

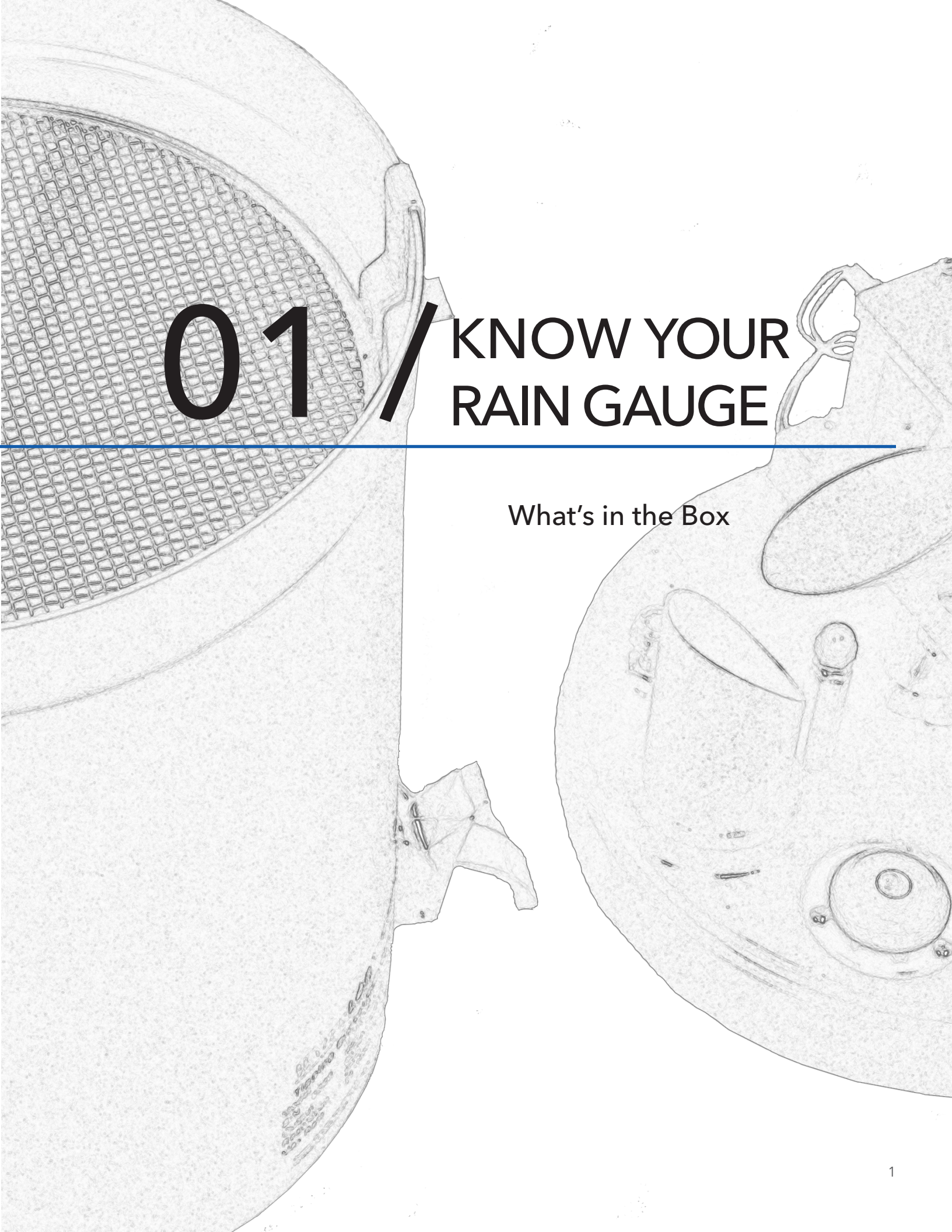

01

KNOW YOUR RAIN GAUGE

What's in the Box

KNOW YOUR RAIN GAUGE

The WaterLOG® H-3401 SDI is a Tipping Bucket Rain Gauge with built-in SDI-12 electronics. The SDI-12 feature converts a standard tipping bucket rain gauge into a “smart” SDI-12 sensor with additional capabilities. The H-3401 SDI is easy to use, works with any data recorder / logger with an SDI-12 Interface, and connects directly to any data recorder with an SDI-12 port. It scales the bucket tips into units (inches, meters, etc.) and provides built-in accumulation of daily and total rainfall. The H-3401 SDI also provides mathematical correction for bucket volume errors due to varying rainfall rate.

What’s in the Box

When unpacking your H-3401 Rain Gauge, make sure all the components ordered are received and undamaged from shipping. The basic package includes the following:



Rain Gauge Main Unit



20' Cable

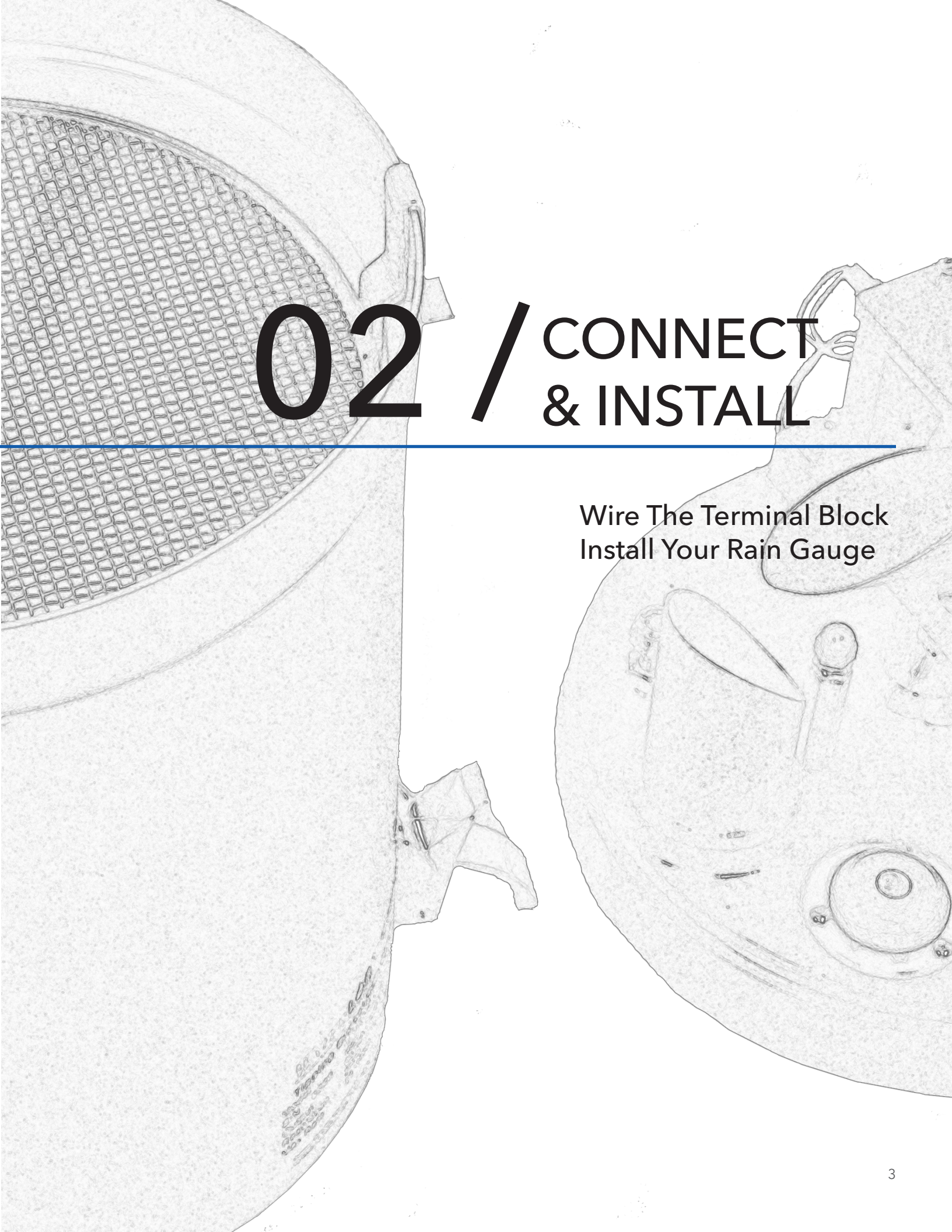

02 / CONNECT & INSTALL

Wire The Terminal Block
Install Your Rain Gauge

CONNECT & INSTALL

Wire The Terminal Block

The H-3401 SDI Rain Gauge has a 6-pin “WAGO” wiring terminal block for connecting the data logger and power. The terminal block has spring clamp terminals which work with both large and small wires and provide reliable long-term connections. To open the spring clamp to insert or remove a wire, insert a small flat screwdriver blade in the square opening adjacent to the wire and twist or pry carefully to one side. The image to the right shows a wiring diagram.

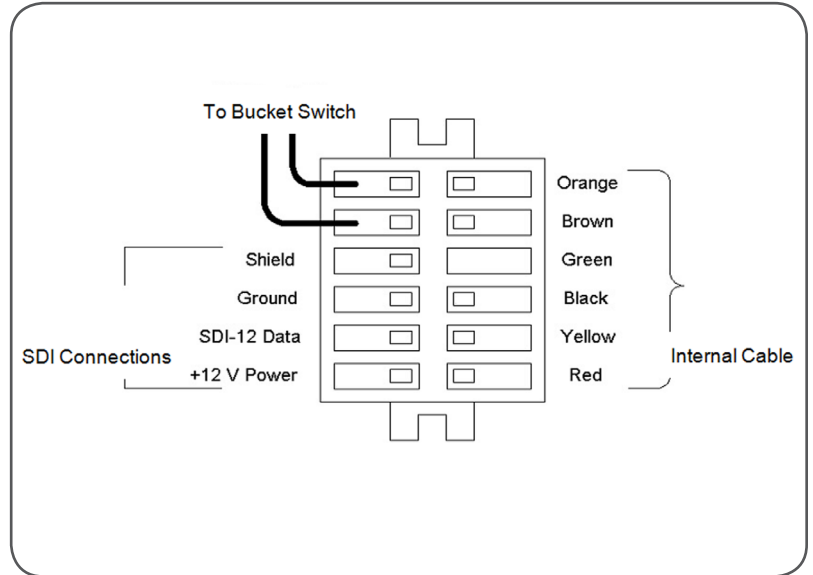

Words of Caution: Keep the lead wires as short as possible. Use shielded cables in noisy environments.

Install Your Rain Gauge

Install the H-3401 SDI Rain Gauge in an open location where it will not be in the rain shadow of trees or buildings. A rooftop location helps prevent vandalism and the accumulation of leaves and debris. Bolt or screw the 3-mounting feet to the structure to prevent upset in high winds. Adjust the three self-leveling screws until the “bulls eye” level is centered.

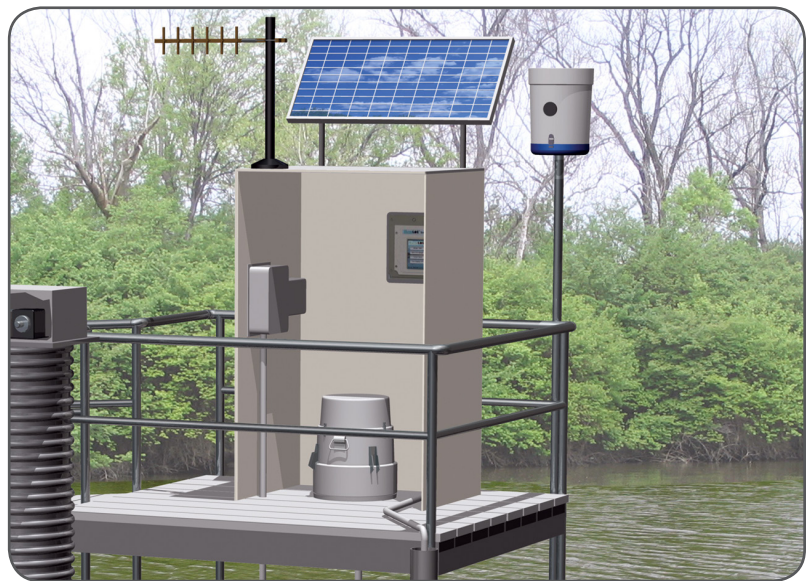

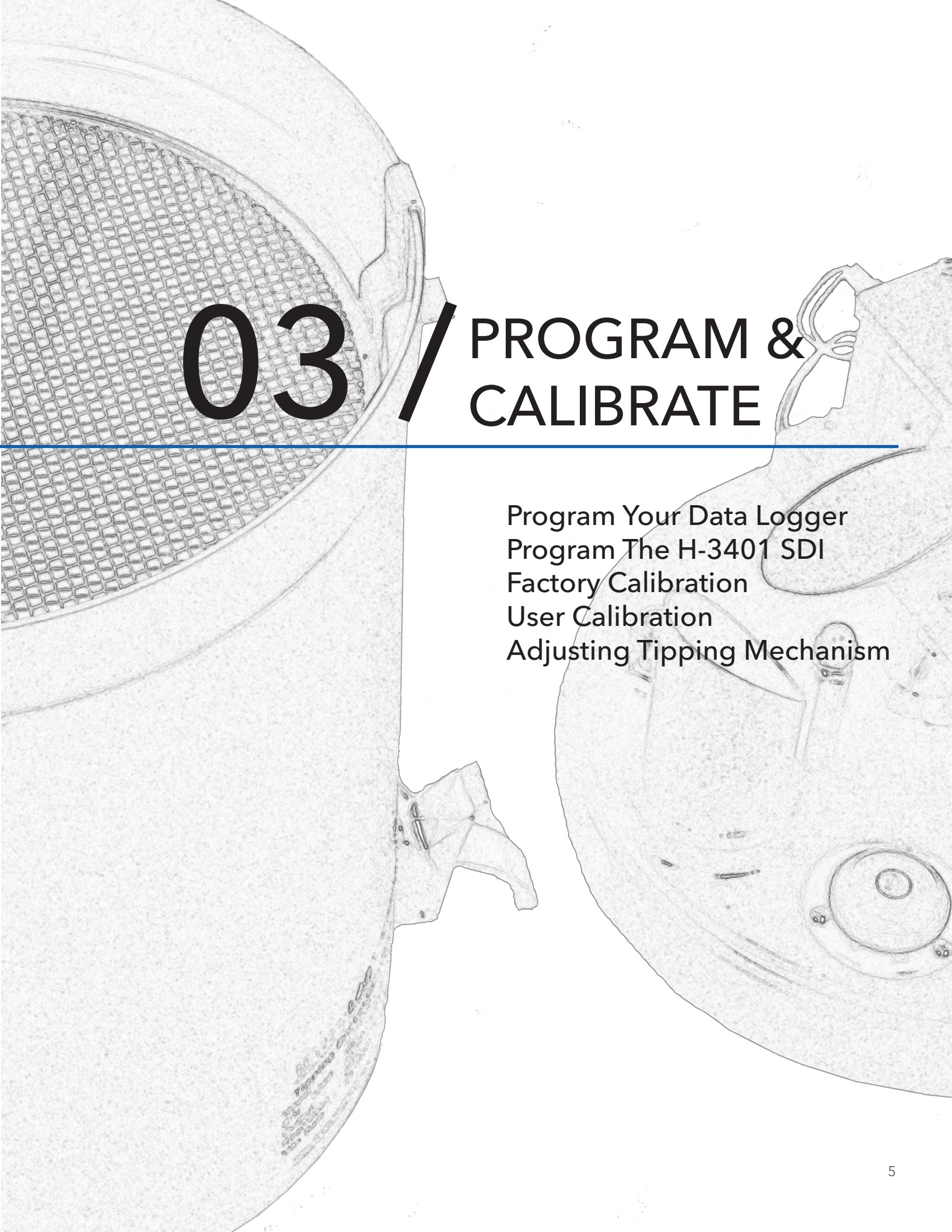
A detailed technical drawing of a rain gauge, showing the tipping bucket mechanism and the data logger housing. The drawing is rendered in a light gray, wireframe style. The number '03' is prominently displayed in the upper left quadrant, followed by a large diagonal slash. To the right of the slash, the words 'PROGRAM & CALIBRATE' are written in a bold, sans-serif font. Below this, a list of tasks is provided: 'Program Your Data Logger', 'Program The H-3401 SDI', 'Factory Calibration', 'User Calibration', and 'Adjusting Tipping Mechanism'. A horizontal blue line runs across the page, separating the title from the list of tasks. The background of the drawing shows the intricate details of the gauge's internal components, including the bucket, the tipping mechanism, and the data logger's internal structure.

03 /

PROGRAM & CALIBRATE

Program Your Data Logger
Program The H-3401 SDI
Factory Calibration
User Calibration
Adjusting Tipping Mechanism

PROGRAM & CALIBRATE

Program Your Data Logger

You must prepare your data logger to receive and record the H-3401 SDI data. Since data recorders differ widely, refer to your recorder manufacturer's directions. In general, program the data recorder to input five values via the SDI-12 port. Usually only one or two of the parameters is actually recorded. Your data recorder must issue an "aM!" command then collect the data with a "aD0" command (refer to the user manual on waterlog.com/rain-gauge for more detailed instructions).



The 3401SDI places five data values in its data buffer:

+AA.AAA+BBB+CC.CCC+DD.DDD+EE.EEE

Where:

+AA.AAA	= Rainfall accumulation since last measurement	(mm/in of rain)
+BB	= Number of raw bucket tips since last measurement	(counts)
+CC.CCC	= Total rainfall accumulation since reset.	(mm/in of rain)
+DD.DDD	= Total rainfall accumulation today	(mm/in of rain)
+EE.EEE	= Total rainfall accumulation yesterday	(mm/in of rain)

All five of these parameters are automatically reset at power-up, or manually with the extended SDI-12 "aXRA" Reset Accumulators command. NOTE: There are also some additional measurement commands, M1, M1C, C1 and C1C that will return the following data.

+AA.AAA+BBB+CC.CCC or +AA.AAA+BBB+CC.CCC+KKKK

Where:

+AA.AAA	= Uncompensated rainfall accumulation since last measurement	(mm/in of rain)
+BB	= Number of raw bucket tips since last measurement	(counts)
+CC.CCC	= Uncompensated total rainfall accumulation since reset.	(mm/in of rain)
+KKKK	= CRC	

Program SDI-12

The H-3401SDI comes from the factory with the following settings:

SDI Address: 0
Slope: 1.0
Daily Reset Time: 00:00:00
Time of day: 00:00:00

With these values the data will be in units of inches of rainfall. The setup is stored in EEPROM within the 3401SDI and will not be lost if the power is disconnected. The extended commands for changing the slope and sensor address are described in detail in the user manual (found on waterlog.com/rain-gauge). If more than one sensor is to be connected to the SDI-12 bus, make certain each sensor has a unique sensor address. In some cases the user may wish to preset the H-340's Total Accumulation value to match the current rainfall of the water year. The H-340 has an offset value stored in memory which is automatically added to the Total Accumulation value. The offset value can be written or read with two extended SDI-12 commands ("aXWO" and "aXRO"), see Chapter 2 for details. Please note both the Total Accumulation and Offset values are reset at power-up, or with the extended SDI-12 Reset Accumulators ("aXRA") command. To change the Total Accumulation to a new value you must first reset the accumulators with the "aXRA" command, then set the offset with the "aXWO" command.

On-Site User Calibration

To calibrate your H-3401 SDI Rain Gauge on-site, follow the steps outlined below.

1. You will first need to connect the gauge to your PC or Laptop. To do this, use the Rain Gauge SDI-12 output, supplied cable and a Sidekick H-4191 to interface the Rain Gauge with a PC/Laptop (see the wiring diagram on page 4).

2. Begin the wet testing - start with a rough setup and balance check.

A) Make sure the bucket stopper bolts are still tight. These have been carefully adjusted at the factory and should not have come loose. If they are tight, then don't loosen or adjust them until after the Rain Gauge has been tested. If they are loose, set them to the height listed below and then re-tighten them.

Rain Gauges with .01" buckets set to 1.00 inch both sides.

Rain Gauges with .2mm buckets set to 1.08 inch both sides.

B) Set the Rain Gauge on a platform or workbench and elevate it so that it sits 3-4 inches above the work surface. You can also use a work surface with through holes in it—place the Rain Gauge over the holes and run the hoses through the holes. Use the bullseye level and wing nuts to level the Rain Gauge's main triangular plate.

C) Connect the supplied hose to the barbed fittings on the bottom of the Rain Gauge, and then run each hose into a separate graduated cylinder. Be sure the cylinders are empty and dry before starting the test.

PROGRAM & CALIBRATE

D) If you want to perform a simplified balance test that does not require a PC or SDI-12 software, you can do the following:

- Make sure the hoses are connected and running into separate 200 mL Graduated Cylinders
- Insert the special bottle and fitting upside down into the rain gage bucket
- Pour approximately 200ml of water into the bottle and let it run through the rain gage. The exact amount of water is not important at this step because we are only checking the Rain Gauge bucket's balance (side-to-side), not the actual rain fall accuracy.
- Let all the water run through the bottle and rain gage, then carefully remove the white housing and tip the bucket once more to allow all the water to run out.
- Carefully check the amount of water in each of the graduated cylinders. They should have nearly the same amount of water in each cylinder (within 5% of each other).

Adjust The Tipping Bucket Mechanism

Adjusting the tipping mechanism on the H-3401 consists of adjusting the stop posts to reduce or increase the volume of water the bucket can hold before it tips. As the stop post rises the volume of water the bucket on the opposite side decreases.

1. To adjust for too many tips (need more rainfall volume), lower the stop post on the opposite side of the bucket that is tipping too early. Re-lock the nut.

2. To adjust for too few tips (need less rainfall volume), raise the stop post on the opposite side of the bucket that is tipping too late. Re-lock the nut.

3. To adjust for equal amounts of water in each bucket, use a pipet to put a set amount of water into each bucket ensuring the bucket tips with a specific volume of water in the bucket. Adjust the stop post heights to ensure the buckets tip at the proper volume of water

0.01" - 8.24 mL

0.2mm - 6.49 mL

0.1mm - 3.24 mL

Volume Test

In this test, a known amount of water is run through the Rain Gauge at a controlled rate. The Rain Gauge will convert this into a Rain Fall readout in inches or millimeters (depends on the model).

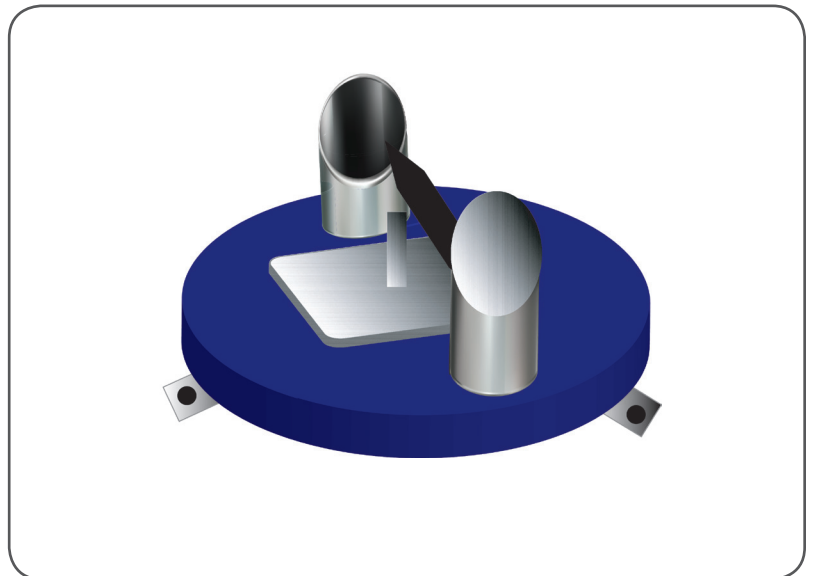

Program & Calibrate

The user will then perform their own calculation based on the formulas below. Compare calculations to the Rain Gauge readings to see if they match.

1. Reset the accumulator, type '0XRA' in the command line of the Windows SDI Terminal
2. Hit the 'SDI DoltAll' command and make sure it returns all 'Zeros'. This confirms the gauge reset.
3. Run approximately 800mL to 1000mL of water through the Rain Gauge by pouring it into the special bucket. You will have to fill the bucket several times because it won't hold 800mL at once.
4. When you are done running the water through the Gauge, remove the white cover and tip the bucket one more time to make sure it is empty. Carefully measure the volume in the graduated cylinders and record it below under 'Volume (ml)'.
5. Calculate the amount of rain fall (in. or mm.) that the 'Volume (ml)' equals based on the formulas at the bottom of the page. Use the formula (in. or mm.) that corresponds to your Rain Gauge model and record it.

$$\begin{aligned} \text{VolMeas in Inches} &= \text{Volume (ml)} \times .001214 \\ \text{VolMeas in Millimeter} &= \text{Volume (ml)} \times .030836 \end{aligned}$$

6. Hit the 'SDI DoltAll' command in the Windows SDI Terminal and record the results below. The readout should look similar to the diagram below:

Received> 0 +.950 + 4 + 2.354 + .950 + 1.404

Received> 0+(todays reading)+(number of tips)+(total reading)+(today's reading)+(yesterday's reading)

1st Test Attempt (test as many times as needed)

Record	Rain gauge
Time _____	#Counts(Tips)_____
Volume (ml) _____	VolBucket _____ Hit "SDI DoltAll"
VolMeas(mm) _____	% Error _____

7. Compare the measurements. Check to see that the amount of rain fall the Rain Gauge reported is the same as the amount that you measured and calculated. They should be within 3% of each other using the formula below.

$$\%Error = \frac{\text{VolMeas} - \text{VolBucket}}{\text{VolMeas}} \times 100\%$$

8. Make adjustments if needed. Verify percent error is less than 3%.
 - If Gauge reads high, decrease the tip speed (1/4 to 1/2 a turn *clockwise* at a time is recommended).
 - If Gauge reads low, raise the post to increase tip speed. (1/4 to 1/2 a turn *counterclockwise* at a time is recommended).

If you are not comfortable making these adjustments, return to the factory for calibration.

What Can Xylem Do For You?

Xylem |'zīləm|

- 1) The tissue in plants that brings water upward from the roots;
- 2) a leading global water technology company.

We're 12,900 people unified in a common purpose: creating innovative solutions to meet our world's water needs. Developing new technologies that will improve the way water is used, conserved, and re-used in the future is central to our work. We move, treat, analyze, and return water to the environment, and we help people use water efficiently, in their homes, buildings, factories and farms. In more than 150 countries, we have strong, long-standing relationships with customers who know us for our powerful combination of leading product brands and applications expertise, backed by a legacy of innovation.

For more information on how Xylem can help you, go to www.xyleminc.com



a xylem brand

YSI Incorporated
1700/1725 Brannum Lane
Yellow Springs, Ohio, 45387, USA

Request a Quote

Tel: +1.435.753.2212
Email: sales@waterlog.com
Internet: www.waterlog.com

Place an Order

Tel: +1.937.767.7241
Email: orders@ysi.com

Customer Support

Tel: +1.937.767.2772

©2014 Xylem Inc.
Item#360427 dwg#360427
February 2014 Rev C